

Dehumidifier WDH-725DG

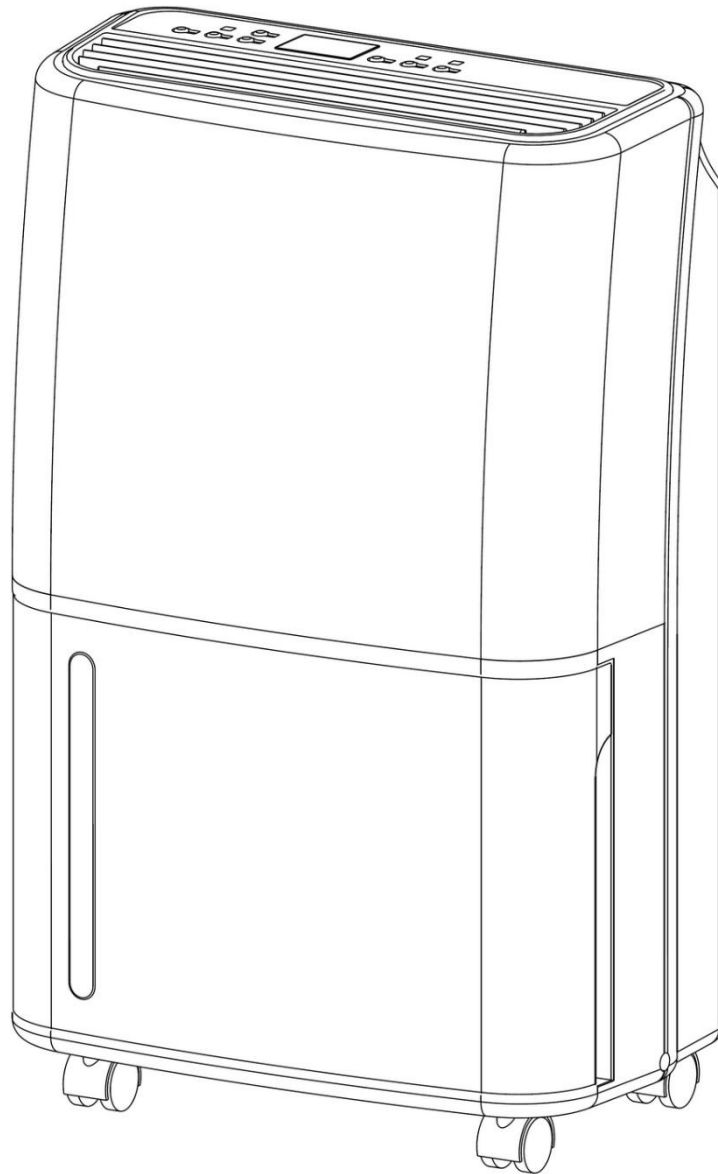

Dear customer,

You have chosen a high quality product. So that you have much joy with this product, here are a few hints:

After the transport:

Since the unit works with refrigerant, improper transport can sometimes occur despite careful instructions on the cardboard box. For this reason, we ask you to let the unit stand upright for 4 hours so that the refrigerant in the unit can settle properly again.

In case of any problems:

We hope the device meets your expectations! If, despite the greatest possible care, there should be any reason for a complaint, please contact us briefly, as we are very concerned about your satisfaction and would like to clear up any misunderstanding.

At first operation:

Since the inner pipelines come into contact with moisture for the first time, it can take up to approx. 3 hours, depending on the humidity, until the liquid collects for the first time in the condensation tank.

Starting-time / delay:

To protect the compressor, it does not switch on again immediately after the unit has stopped operation or there has been an interruption in operation (e.g. emptying the condensing tank). Initially, only the fan runs for one minute. After this minute the unit switches off completely for two minutes and goes into a so-called "protection mode" in which neither the fan nor the compressor is running. Once the two minutes of the protection mode have elapsed, the unit starts operating normally and runs with the fan and compressor.

Room humidity and dehumidification capacity:

If you want to check the room humidity and the associated dehumidification performance with your own moisture meter (hygrometer), please avoid mounting this moisture meter on a wall, as this will falsify the true moisture content of the room air. See also the explanations under Troubleshooting!

Important safety instructions:

- When setting up, using and cleaning the unit, proceed strictly according to the operating instructions and read them very carefully !!
- Supervise the dehumidifier if there are children near the unit.
- Watch out for electricity. Do not insert any objects into the appliance !
- Do not place any objects on the dehumidifier !
- Do not block the exhaust air fins of the unit and please ensure sufficient space on and around the air outlet!
- Ensure sufficient air supply to the unit, otherwise it may lead to reduced performance and in the worst case to overheating and/or fire!
- Make sure that no moisture gets into the electrical system of the device!
- Only use the recommended voltage for the operation of the device!
- Make sure that the power cord is unfolded (untied) before connecting it to the power outlet !
- Make sure that the plug is clean and properly connected to the socket before starting the appliance !
- In the event of problems or damage, always contact the manufacturer immediately and never repair yourself!
- Never reach near the plug or socket with wet hands!
- Please do not use multiple sockets to operate the dehumidifier!
- Do not repair defective or damaged cables on the device yourself, you could receive a severe electric shock!
- Make sure that there are never easily flammable substances (e.g. gases/oils etc.) in the vicinity of the device!
- If you do not use the device for a longer period of time, switch it off and unplug it from the mains!
- This device is not intended for use by persons (including children) with impaired physical, sensory or mental abilities or for lack of experience and/or knowledge, unless they are supervised by or have received instructions from a person responsible for their safety on how to use this device.
- Do not make any changes to the device !
- The dehumidifier should not be operated or stored in a room with other burning / heating equipment!

Please switch off the device immediately and disconnect it from the power supply if something seems to be wrong! In this case, please contact a specialist or the manufacturer and do not attempt to repair the device yourself !!

Example: Fan does not run during operation, fuse has jumped out or the compressor is rattling loudly.

Important operating and safety instructions concerning the refrigerant R290 in this unit:

- Read these instructions carefully and observe them strictly !
- The unit works with refrigerant R290. This refrigerant is easily flammable and explosive if the safety instructions are not observed!
- The device should not be stored or operated in a room with burning / heating devices or open fire !
- Please note that the refrigerant is odourless and a leak cannot therefore be detected immediately by an odour !
- Make sure that the exhaust air outlet is always ensured and is not obstructed by other objects !
- Ensure a minimum distance of at least 50 cm from open flames and heating elements !
- The device should be installed, operated and stored in a room with a minimum size of 8 m² !
- When cleaning, proceed strictly according to the manufacturer's instructions and do not use any additional heat sources to accelerate the defrosting process of the device if necessary !

This unit has parts that must not be replaced or repaired !

The refrigerant cannot be renewed or replaced !

Do not carry out any repairs or modifications on your device yourself !

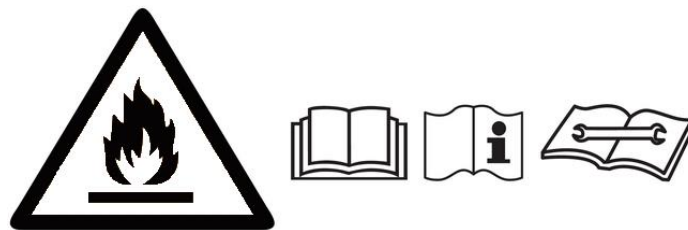

Description of the device parts:

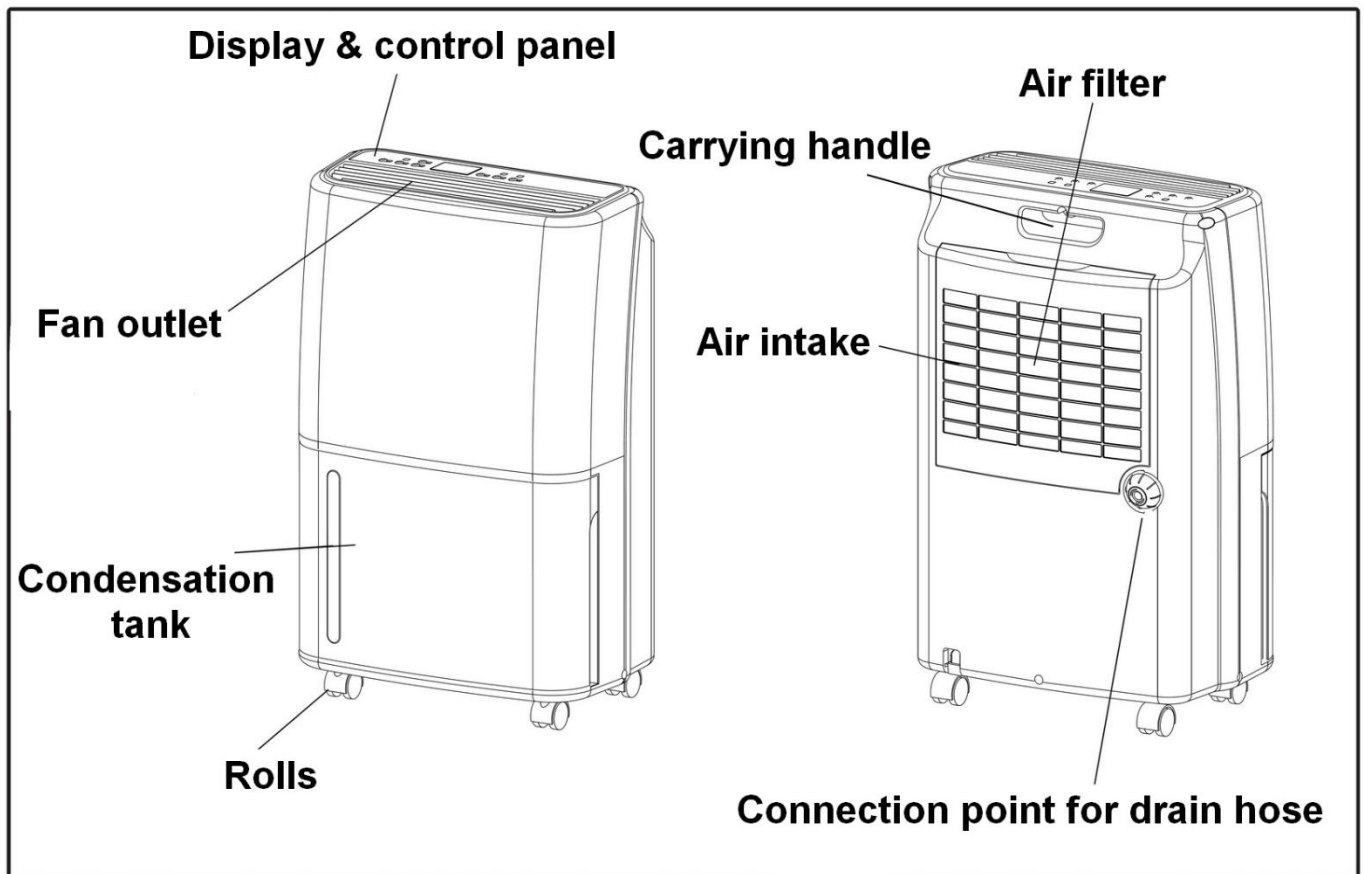

Functional description:

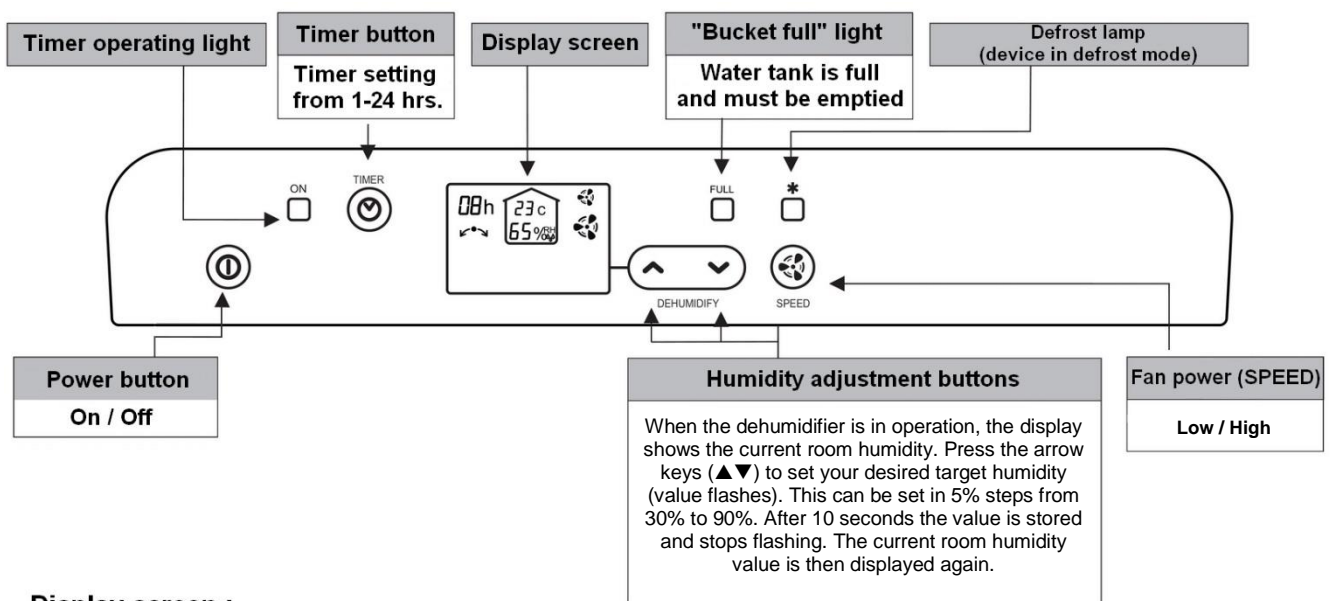

Display screen :

08h : Timer indicator



: Current room temperature

: Current room humidity



: Fan power low



: Fan power high

Instruction:

1. Commissioning

- 1.1. Plug the power plug properly into the wall outlet.
- 1.2. Check that the condensation tank is properly seated in the dehumidifier. (During initial operation, the "Condensation tank full" light may light up. Simply pull out the condensation tank for a short time and then press it in again immediately and you are ready to go.)
- 1.3. Switch on the device with the power button (On/Off). Now press the humidity adjustment keys (arrow keys) and set your target humidity as desired. The target value of 30% humidity actually corresponds to continuous operation!
- 1.4. Use the "SPEED" button to select between low and high fan power / air circulation. Then adjust the movable blades of the fan output in your desired direction.
- 1.5. If you want to activate/use the timer function (function for determining the remaining time or function for specifying a start time), press the TIMER key.

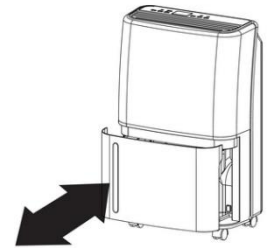

Determination of the remaining time: Press the TIMER button during operation to select the desired remaining time of the dehumidifier. (A value between 1 and 24 hours can be selected). After this selected operating time has elapsed, the unit switches off automatically.

Determination of a start time: When the dehumidifier is switched off, press the TIMER button to select the desired start time. (A value between 1 and 24 hours can be selected). After this selected time has elapsed, the unit switches on automatically (with the settings last used).

2. Emptying the condensation tank / When the "Bucket Full" light is on

When the condensation tank is full, the signal lamp lights up and the dehumidifier automatically stops dehumidifying. Remove the condensation tank and empty it. After you have properly pushed the condensation tank back into the unit, dehumidification operation starts again automatically.

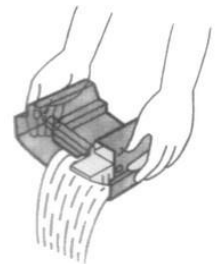

3. Connecting a hose for continuous condensate drainage

- 3.1. You need a ½-inch (diameter 13 mm) plastic hose.
- 3.2. Loosen the screw cap on the rear right side of the dehumidifier and keep it in a safe place! (See Fig. 1)
- 3.3. Next, remove the black rubber plug from the drain for the condensation hose and also pick up the black rubber plug well! (See Fig. 2)
- 3.4. Now connect the plastic hose to the connection tap by pushing it firmly over the tap.

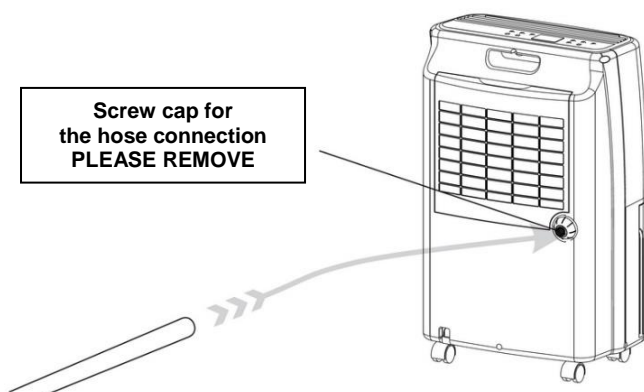

Fig. 1

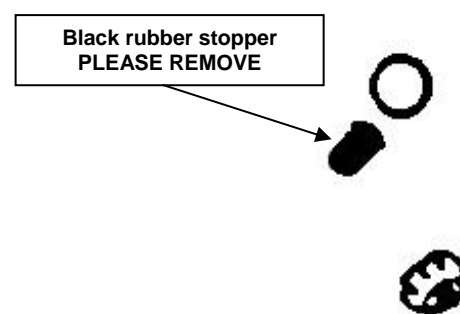
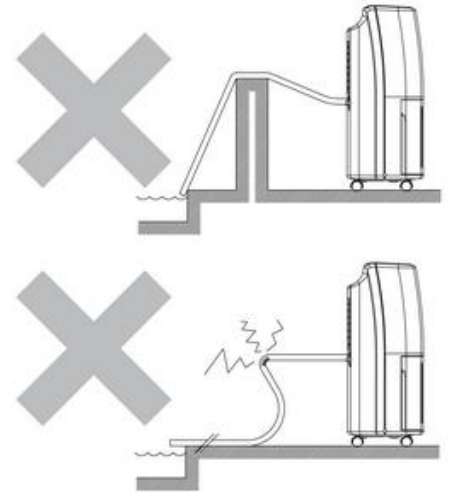
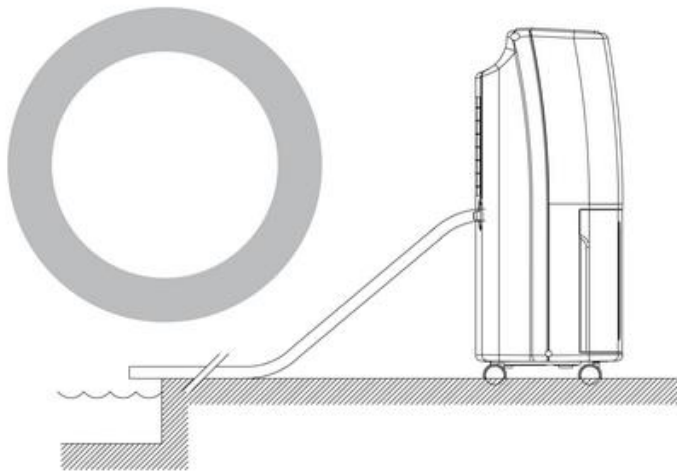

Fig. 2

3.5. Correct drainage of condensation water with hose connection! Make sure that the hose is always slightly inclined (see following diagrams).



4. Other operating information

- 4.1. Do not disconnect the mains plug by pulling on the power cable !
- 4.2. Do not use insect, oil or paint spray etc. near the dehumidifier. This can cause damage to the unit or even fire!
- 4.3. Do not place the unit on an inclined or uneven surface !
- 4.4. Always keep a distance of approx. 20 cm from the wall to avoid possible overheating of the device. Please also ensure a distance of approx. 50 cm to the top when drying laundry !
- 4.5. For an effective and economical dehumidification operation, please close all doors and windows in the dehumidifier room!
- 4.6. Please keep the device away from heat sources !
- 4.7. Always hold and transport the device in its proper and upright position!

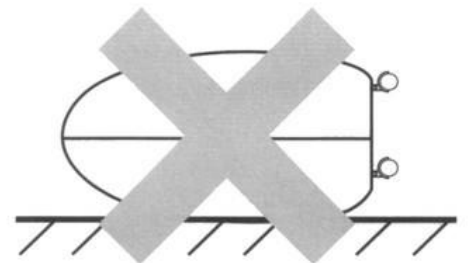
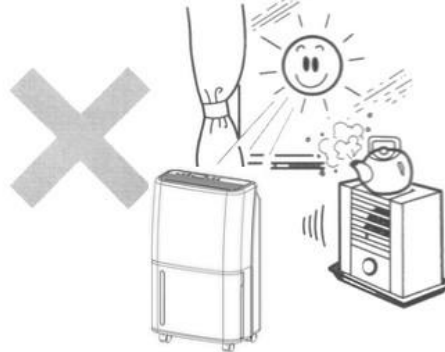
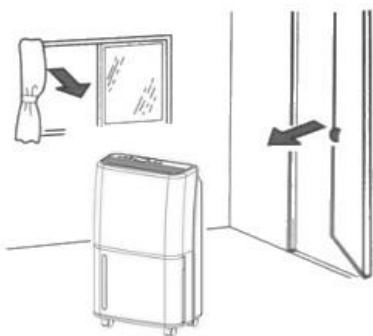
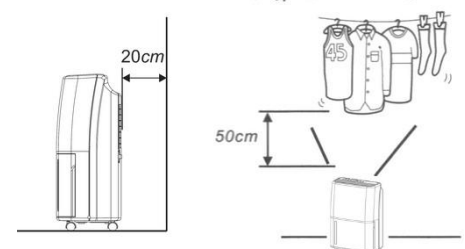
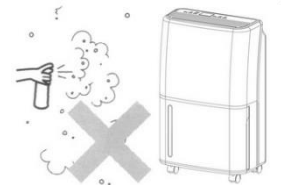
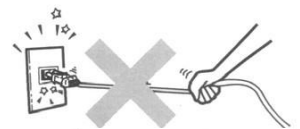

5. Cleaning

5.1. Cleaning the housing

- Please disconnect the mains plug before cleaning the dehumidifier.
- Use only mild detergents to clean your dehumidifier.
- NEVER hose down your dehumidifier (e.g. with water or similar).

5.2. Cleaning the air filter

The air filter filters fluff, hair and coarse dust. The air filter is coated with an antibacterial glaze to inhibit the growth of bacteria. In addition, the air filter ensures that less dust is deposited on the cooling fins, ensuring greater efficiency.

- Always clean the filter if it can be assumed that the air intake through the dirty air filter is reduced !
- Grasp the top edge of the air filter and pull it toward you to remove the air filter from its holder. (See Figure 1)
- It is best to clean the air filter carefully under lukewarm water or with a weakly adjusted (suction power) vacuum cleaner. (See Fig. 2)
- Replace the cleaned air filter in its holder – READY.

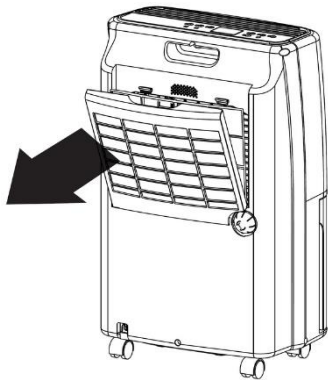

Fig. 1

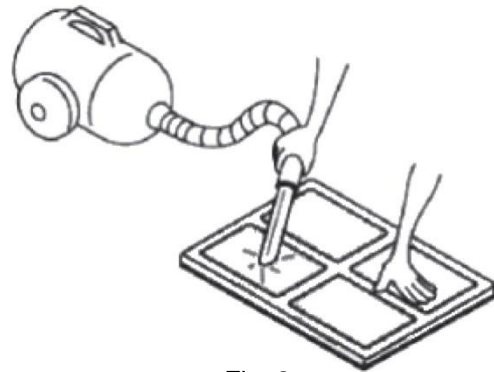

Fig. 2

Technical data:

Model:	WDH-725DG
Voltage:	220 ~ 240V / 50Hz
Max. Power consumption:	420 W (1.9 A)
Compressor:	Rotary Compressor
Dehumidification capacity (ideal):	25 Ltr./day (35°C / 90% r.H.)
Dehumidification capacity (standard):	20 Ltr./day (30°C / 80% r.H.)
Condensation tank:	Around 3 Litres
Refrigerant:	R290 (86 g)
Protection class:	IPX0
Measurements (H/W/D):	590 x 360 x 240 mm
Weight:	13,5 kg
Application range:	5°C ~ 32°C

The technical data are subject to change without notice !

Troubleshooting:

The unit does not dehumidify enough / Too little water accumulates in the condensation tank

Please remember that it is not primarily a matter of obtaining as much condensation water as possible, but of drying and/or keeping dry the room air or ceilings, walls and inventory !

Also remember that the dehumidifier can only extract moisture from the air and only indirectly from materials. Depending on the condition of the ceilings, walls and inventory, it can take several weeks for the stored moisture to be released into the air again !! For this reason, we also recommend that if you use your own hygrometer, you place it as freely as possible away from walls and ceilings, otherwise the determined humidity value of the room air will be falsified !!

As with all dehumidifiers, dehumidification performance is decisively influenced by the following factors:

A) Humidity content of the room air and B) Heat/temperature in the room.

For safety reasons, therefore, an extract from the dehumidification table for DURATION OPERATION:

35 degrees and <u>80% r.H.</u> = ca. 22 Litres	and at <u>90% r.H.</u> = ca. 25 Litres	and at <u>60% r.H.</u> = ca. 13 Litres
30 degrees and <u>80% r.H.</u> = ca. 20 Litres	and at <u>90% r.H.</u> = ca. 22 Litres	and at <u>60% r.H.</u> = ca. 11 Litres
20 degrees and <u>80% r.H.</u> = ca. 11 Litres	and at <u>90% r.H.</u> = ca. 14 Litres	and at <u>60% r.H.</u> = ca. 7 Litres
15 degrees and <u>80% r.H.</u> = ca. 9 Litres	and at <u>90% r.H.</u> = ca. 11 Litres	and at <u>60% r.H.</u> = ca. 5 Litres
10 degrees and <u>80% r.H.</u> = ca. 6 Litres	and at <u>90% r.H.</u> = ca. 8 Litres	and at <u>60% r.H.</u> = ca. 4 Litres
5 degrees and <u>80% r.H.</u> = ca. 5 Litres	and at <u>90% r.H.</u> = ca. 6 Litres	and at <u>60% r.H.</u> = ca. 3 Litres

All values are approx. per day (fluctuation tolerance) for a measurement directly at the instrument input and of course these values only apply if temperature and moisture content are constant !!

The device rattles or makes running noises

Running noises are mostly caused by the air filter unit. We kindly ask you to remove the air filter and check whether the running noises are still present ?

Often an unfavourable position of the dehumidifier is also the reason for higher running noises. Try to change the position a little, because most of the time the running noises will disappear. Optimum and particularly quiet operation can be achieved if the dehumidifier stands on a piece of carpet, doormat or similar during operation ! (Stone flooring, tiles, laminate or parquet, on the other hand, increase the operating noise of the dehumidifier !)

The device is leaking or water is leaking

In this context we would like to give you the following information:

A "leak" in your dehumidifier is actually impossible, unless the main frame is broken and something like this can be excluded without the use of force.

If your water is still leaking, then the condensate will probably come from the "emergency drain" located above the float on the right side (square recess). The reason for this is that the normal drain is prevented.

This can have the following causes:

1. The most common cause is slight soiling in the drip tray or drain (e.g. from dead insects, dirt or the like) and therefore the condensate cannot drain normally. In this context, please check the drain once or shake the unit briefly to the headstand position. Make sure that you wait at least 4 hours afterwards before switching on the device again!
2. The device has no straight stand.
3. It is possible that only a larger piece of ice has detached from the cooling fins of your dehumidifier and this will lead to short-term clogging. We therefore recommend that you disconnect the appliance completely from the power supply for one day, after which the appliance should no longer be "leaky".

Additional:

Guarantee declaration:

Without prejudice to the statutory warranty claims, the manufacturer grants a warranty in accordance with the laws of your country, but at least 1 year (in Germany 2 years for private persons). The warranty begins on the date of sale of the device to the end user.

The guarantee extends exclusively to defects which can be traced back to material or manufacturing defects.

Warranty repairs may only be carried out by an authorized service center. To claim your warranty, please enclose the original sales receipt (with date of purchase). The following are excluded from the guarantee:

- Normal wear
- Improper use, such as overloading the device or unauthorized accessories
- Damage due to external influences, use of force or foreign objects
- Damage caused by non-observance of the operating instructions, e.g. connection to an incorrect mains voltage or non-observance of the installation instructions
- Completely or partially dismantled devices

Conformity:

The dehumidifier itself and/or parts thereof have been tested and manufactured by the following (safety) standards:

Tested by TÜV Süd "GS", and of course with CE conformity and EMC conformity.

Tested safety according to: EN 60335-2-40:2003/A13:2012
EN 60335-1:2012+A11:2014+A13:2017
EN 62233:2008
AfPS GS 2014: 01 PAK

CE (LVD) conformity tested according to: EN 60335-2-40:2003/A13:2012
EN 60335-1:2012+A11:2014+A13:2017
EN 62233:2008

EMC conformity tested according to: EN 55014-1:2006/A2:2011
EN 55014-2:1997/A2:2008
EN 61000-3-2:2014
EN 61000-3-3:2013

Correct disposal of this product:



Within the EU, this symbol indicates that this product must not be disposed of with household waste. Old appliances contain valuable recyclable materials which should be recycled. In addition, the environment and human health should not be harmed by uncontrolled waste disposal. For this reason, please dispose of old appliances via suitable collection systems or send the appliance to the place where you purchased it for disposal. The latter will then recycle the device.

We wish you a lot of fun with this device

Aktobis AG

Keep these instructions for use in a safe place !

